

# SIRUBA®

銀箭牌工業用縫紉機  
INDUSTRIAL SEWING MACHINE







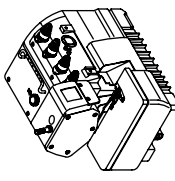
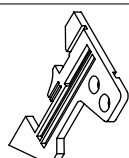
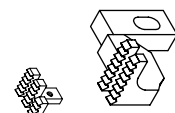

# 700H

## 零件圖 PARTS LIST

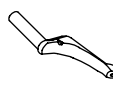







CE

 高林股份有限公司  
KAULIN MFG. CO., LTD.

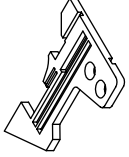
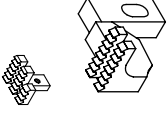
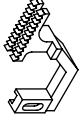
										
機 型 MODEL	針 板 NEEDLE PLATE	送 具 FEED DOG	送 具 FEED DOG	押 具 PRESSER FOOT	勾 針 LOOPER	針 留 NEEDLE CLAMP	束 子 COLLAR	衝 程 CRANK	衝 程 CRANK	針 號 NEEDLE
737H-504M1-15	E934D	D438	D912	P152D-2	LP26	KG231-E	KJ10F	KF87-A	KJ09B-E	DC27 #9
737H-504M2-04	E800	D440	D095	P253E-3	LP26	KG231-E	KJ10F	KF87-A	KJ09B-E	DC27 #11
737H-504M2-04CT	E800C	D440	D095	P253E-3	LP26	KG231-E	KJ10F	KF87-A	KJ09B-E	DC27 #11
737H-504M2-04LFC-2	E800	D440	D095	P101-3	LP26	KG231-E	KJ10F	KF87-A	KJ09B-E	DC27 #11
737H-504M2-04LFC-2/EC	E800C	D440	D095	P101-3	LP26	KG231-E	KJ10F	KF87-A	KJ09B-E	DC27 #11
737H-504M2-04TR	E011	D015	D011	P101-3	LP26	KG231-E	KJ10F	KF87-A	KJ09B-E	DC27 #11
737H-504M2-04VT	E800	D440	D095	P253E-3	LP26	KG231-E	KJ10F	KF87-A	KJ09B-E	DC27 #11
737H-504M2-04WR/LF-B	E001				LP26	KG231-E	KJ10F	KF87-A	KJ09B-E	DC27 #11
737H-504M3-05PZ	E797	D440	D674	PZ01-A	LP26	KG231-E	KJ10F	KF87-A	KJ09B-E	DC27 #18
737H-504M3-05	E797	D440	D674	P230-3	LP26	KG231-E	KJ10F	KF87-A	KJ09B-E	DC27 #11
737H-504M3-05CT	E797C	D440	D674	P230-3	LP26	KG231-E	KJ10F	KF87-A	KJ09B-E	DC27 #11
737H-504M3-05VT	E797	D440	D674	P230-3	LP26	KG231-E	KJ10F	KF87-A	KJ09B-E	DC27 #11
737H-504M5-04BK	E589F	D969	D675	P975-3	LP26	KG231-E	KJ10F	KF87-A	KJ09B-E	DC27 #11
737H-504M5-04BK/VT	E589F	D969	D675	P975-3	LP26	KG231-E	KJ10F	KF87-A	KJ09B-E	DC27 #11
737H-505F1-04	E784	D438	D674	P152D-3	LP26	KG231-E	KJ10F	KF87-A	KJ09B-E	DC27 #9
737H-505F1-04ES	E784	D438	D674	P152D-3	LP26	KG231-E	KJ10F	KF87-A	KJ09B-E	DC27 #9
737H-505F1-04VT	E784	D438	D674	P152D-3	LP26	KG231-E	KJ10F	KF87-A	KJ09B-E	DC27 #9
737H-504M3-04	E796	D440	D674	P230-3	LP26	KG231-E	KJ10F	KF87-A	KJ09B-E	DC27 #11
737H-505F1-04ES/VT	E784	D438	D674	P152D-3	LP26	KG231-E	KJ10F	KF87-A	KJ09B-E	DC27 #9
737H-504M2-04EC	E800C	D440	D095	P253E-3	LP26	KG231-E	KJ10F	KF87-A	KJ09B-E	DC27 #11
737H-504M1-15VT	E934D	D438	D912	P152D-5	LP26	KG231-E	KJ10F	KF87-A	KJ09B-E	DC27 #9
737H-504M2-04TR/EC	E011C	D011	D015	P101-3	LP26	KG231-E	KJ10F	KF87-A	KJ09B-E	DC27 #11
737H-504F1-04	E784	D438	D674	P152D-3	LP26	KG231-E	KJ10F	KF87-A	KJ09B-E	DC27 #9

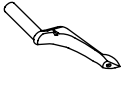
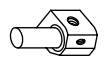
## 規格件表 CONVERSION CHART







# 型別件對照表 MODEL COMPARE LIST

機 型 MODEL										
	針板 NEEDLE PLATE	送具 FEED DOG	送具 FEED DOG	押具 PRESSER FOOT	勾 針 LOOPER	針留 NEEDLE CLAMP	束 子 COLLAR	衝 程 CRANK	衝 程 CRANK	針 號 NEEDLE
747H-512M1-25	E920	D440	D095	P253E-4	LP36	KG242-E	KJ13F	KF86-A	KJ11B-E	DC27 #11*2
747H-512M1-25CT	E920C	D440	D095	P253E-4	LP36	KG242-E	KJ13F	KF86-A	KJ11B-E	DC27 #11*2
747H-514H4-24GA	E919	D958	D095	P136-A	LP26	KG242-E	KJ13F	KF86-A	KJ11B-E	DC27 #11*2
747H-514H4-24GA/CT	E919C	D958	D095	P136-A	LP26	KG242-E	KJ13F	KF86-A	KJ11B-E	DC27 #11*2
747H-514H4-24GA/EC	E919C	D958	D095	P136-A	LP26	KG242-E	KJ13F	KF86-A	KJ11B-E	DC27 #11*2
747H-514H4-24GA/P	E919	D958	D095	P136P-A	LP26	KG242-E	KJ13F	KF86-A	KJ11B-E	DC27 #11*2
747H-514M2-24	E919	D440	D095	P253E-4	LP26	KG242-E	KJ13F	KF86-A	KJ11B-E	DC27 #11*2
747H-514M2-24CT	E919C	D440	D095	P253E-4	LP26	KG242-E	KJ13F	KF86-A	KJ11B-E	DC27 #11*2
747H-514M2-24EC	E919C	D440	D095	P253E-4	LP26	KG242-E	KJ13F	KF86-A	KJ11B-E	DC27 #11*2
747H-514M2-24LF-B	E919	D440	D095	P101-4	LP26	KG242-E	KJ13F	KF86-A	KJ11B-E	DC27 #11*2
747H-514M2-24LFC-2	E919	D440	D095	P101-4	LP26	KG242-E	KJ13F	KF86-A	KJ11B-E	DC27 #11*2
747H-514M2-24LFC-2/EC	E919C	D440	D095	P101-4	LP26	KG242-E	KJ13F	KF86-A	KJ11B-E	DC27 #11*2
747H-514M2-24TG	E919	D440	D095	P254G-4	LP26	KG242-E	KJ13F	KF86-A	KJ11B-E	DC27 #11*2
747H-514M2-24TG/EC	E919C	D440	D095	P254G-4	LP26	KG242-E	KJ13F	KF86-A	KJ11B-E	DC27 #11*2
747H-514M2-24VT	E810C	D440	D095	P253E-4	LP26	KG242-E	KJ13F	KF86-A	KJ11B-E	DC27 #11*2
747H-514M2-25TG	E920	D440	D095	P253G-4	LP26	KG242-E	KJ13F	KF86-A	KJ11B-E	DC27 #11*2
747H-514M2-25	E920C	D440	D095	P253E-4	LP26	KG242-E	KJ13F	KF86-A	KJ11B-E	DC27 #11*2
747H-514M2-25CT	E920C	D440	D095	P253E-4	LP26	KG242-E	KJ13F	KF86-A	KJ11B-E	DC27 #11*2
747H-514M4-23	E804	D440	D674	P230-A	LP26	KG242-E	KJ13F	KF87-A	KJ11B-E	DC27 #11*2
747H-514M4-23CT	E804C	D440	D674	P230-A	LP26	KG242-E	KJ13F	KF87-A	KJ11B-E	DC27 #11*2
747H-514M5-23BK	E591B	D969	D657	P975-4	LP26	KG242-E	KJ13F	KF86-A	KJ11B-E	DC27 #11*2
747H-514M7-23	E804A	D441	D674	P230-A	LP38	KG242-E	KJ13F	KF86-A	KJ11B-E	DC27 #16*2
747H-514M7-23CT	E804AC	D441	D674	P230-A	LP38	KG242-E	KJ13F	KF86-A	KJ11B-E	DC27 #11*2

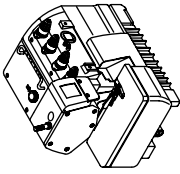
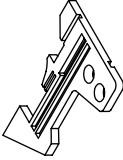
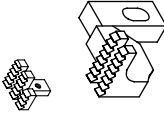
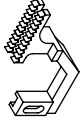
機型 MODEL	針板 NEEDLE PLATE	送具 FEED DOG	送具 FEED DOG	送具 FEED DOG	押具 PRESSER FOOT	勾針 LOOPER	針留 NEEDLE CLAMP	束子 COLLAR	衝程 CRANK	衝程 CRANK	針號 NEEDLE
747H-512M1-25	E920	D440	D095	H445	P253E-4	LP36	KG242-E	KJ13F	KF86-A	KJ11B-E	DC27 #11*2
747H-512M1-25CT	E920C	D440	D095	H445	P253E-4	LP36	KG242-E	KJ13F	KF86-A	KJ11B-E	DC27 #11*2
747H-514H4-24GA	E919	D958	D095	H959	P136-A	LP26	KG242-E	KJ13F	KF86-A	KJ11B-E	DC27 #11*2
747H-514H4-24GA/CT	E919C	D958	D095	H959	P136-A	LP26	KG242-E	KJ13F	KF86-A	KJ11B-E	DC27 #11*2
747H-514H4-24GA/EC	E919C	D958	D095	H959	P136-A	LP26	KG242-E	KJ13F	KF86-A	KJ11B-E	DC27 #11*2
747H-514H4-24GA/P	E919	D958	D095	H959	P136P-A	LP26	KG242-E	KJ13F	KF86-A	KJ11B-E	DC27 #11*2
747H-514M2-24	E919	D440	D095	H445	P253E-4	LP26	KG242-E	KJ13F	KF86-A	KJ11B-E	DC27 #11*2
747H-514M2-24CT	E919C	D440	D095	H445	P253E-4	LP26	KG242-E	KJ13F	KF86-A	KJ11B-E	DC27 #11*2
747H-514M2-24EC	E919C	D440	D095	H445	P253E-4	LP26	KG242-E	KJ13F	KF86-A	KJ11B-E	DC27 #11*2
747H-514M2-24LF-B	E919	D440	D095	H445	P101-4	LP26	KG242-E	KJ13F	KF86-A	KJ11B-E	DC27 #11*2
747H-514M2-24LFC-2	E919	D440	D095	H445	P101-4	LP26	KG242-E	KJ13F	KF86-A	KJ11B-E	DC27 #11*2
747H-514M2-24LFC-2/EC	E919C	D440	D095	H445	P101-4	LP26	KG242-E	KJ13F	KF86-A	KJ11B-E	DC27 #11*2
747H-514M2-24TG	E919	D440	D095	H445	P254G-4	LP26	KG242-E	KJ13F	KF86-A	KJ11B-E	DC27 #11*2
747H-514M2-24TG/EC	E919C	D440	D095	H445	P254G-4	LP26	KG242-E	KJ13F	KF86-A	KJ11B-E	DC27 #11*2
747H-514M2-24VT	E810C	D440	D095	H445	P253E-4	LP26	KG242-E	KJ13F	KF86-A	KJ11B-E	DC27 #11*2
747H-514M2-25TG	E920	D440	D095	H445	P253G-4	LP26	KG242-E	KJ13F	KF86-A	KJ11B-E	DC27 #11*2
747H-514M2-25	E920C	D440	D095	H445	P253E-4	LP26	KG242-E	KJ13F	KF86-A	KJ11B-E	DC27 #11*2
747H-514M2-25CT	E920C	D440	D095	H445	P253E-4	LP26	KG242-E	KJ13F	KF86-A	KJ11B-E	DC27 #11*2
747H-514M4-23	E804	D440	D674	H445	P230-A	LP26	KG242-E	KJ13F	KF87-A	KJ11B-E	DC27 #11*2
747H-514M4-23CT	E804C	D440	D674	H445	P230-A	LP26	KG242-E	KJ13F	KF87-A	KJ11B-E	DC27 #11*2
747H-514M5-23BK	E591B	D969	D657	H974	P975-4	LP26	KG242-E	KJ13F	KF86-A	KJ11B-E	DC27 #11*2
747H-514M7-23	E804A	D441	D674	H446	P230-A	LP38	KG242-E	KJ13F	KF86-A	KJ11B-E	DC27 #16*2
747H-514M7-23CT	E804AC	D441	D674	H446	P230-A	LP38	KG242-E	KJ13F	KF86-A	KJ11B-E	DC27 #11*2

## 規格件表 CONVERSION CHART

# 型別件對照表 MODEL COMPARE LIST

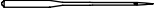
										
機 型 MODEL	針板 NEEDLE PLATE	送 具 FEED DOG	送 具 FEED DOG	押 具 PRESSER FOOT	勾 針 LOOPER	針 留 NEEDLE CLAMP	束 子 COLLER	衝 程 CRANK	衝 程 CRANK	針 號 NEEDLE
757H-516L1-24CT	E834C	D487 D060	H492	P500-A	LP26	KG252-E	KJ10F	KF87-A	KJ09B-E	DC27 #14*2
757H-516L1-35	E839	D487 D060	H492	P504-A	LP26	KG253-E	KJ10F	KF87-A	KJ09B-E	DC27 #14*2
757H-516L1-35CT	E839C	D487 D060	H492	P504-A	LP26	KG253-E	KJ10F	KF87-A	KJ09B-E	DC27 #14*2
757H-516M2-35	E982	D489 D502	H497	P504-A	LP26	KG253-E	KJ10F	KF87-A	KJ11B-E	DC27 #14*2
757H-516M2-35CT	E982C	D489 D502	H497	P504-A	LP26	KG253-E	KJ10F	KF87-A	KJ11B-E	DC27 #14*2
757H-516M2-35PS	E982S	D489 D502	H497	P504S-A	LP26	KG253-E	KJ10F	KF87-A	KJ11B-E	DC27 #14*2
757H-516M2-35PS/EC	E982SC	D489 D502	H497	P504S-A	LP26	KG253-E	KJ10F	KF87-A	KJ11B-E	DC27 #14*2
757H-516M2-55	E986	D489 D502	H500	P502-A	LP26	KG255-E	KJ10F	KF87-A	KJ11B-E	DC27 #14*2
757H-516M2-55CT	E986C	D489 D502	H500	P502-A	LP26	KG255-E	KJ10F	KF87-A	KJ11B-E	DC27 #14*2
757H-516M2-55PS	E986S	D489 D502	H497	P502S-A	LP26	KG255-E	KJ10F	KF87-A	KJ11B-E	DC27 #14*2
757H-516M2-55PS/EC	E986SC	D489 D502	H497	P502S-A	LP26	KG255-E	KJ10F	KF87-A	KJ11B-E	DC27 #14*2
757H-516M2-55/EC	E986C	D489 D502	H500	P502-A	LP26	KG255-E	KJ13F	KF87-A	KJ11B-E	DC27 #14*2
757H-401M1/TW/CT	E110C		H101	P767-A	LP26	KG253-E	KJ13F	KF87-A	KJ09B-E	DC27 #14*2
767H-516M2-324	E989	D971 D502	H497	P233-A	LP26	KG433-E	KJ13F	KF86-A	KJ11B-E	DC27 #11*3
767H-516M2-324/CT	E989C	D971 D502	H497	P233-A	LP26	KG433-E	KJ13F	KF86-A	KJ11B-E	DC27 #11*3
767H-516M2-524	E988	D972 D502	H500	P255-A	LP26	KG455-E	KJ13F	KF86-A	KJ11B-E	DC27 #11*3
767H-516M2-524CT	E988C	D972 D502	H500	P255-A	LP26	KG455-E	KJ13F	KF86-A	KJ11B-E	DC27 #11*3

MODEL	三四線車	五六線車
PARTS NO	KB01E KB22F	KB02E KB23F

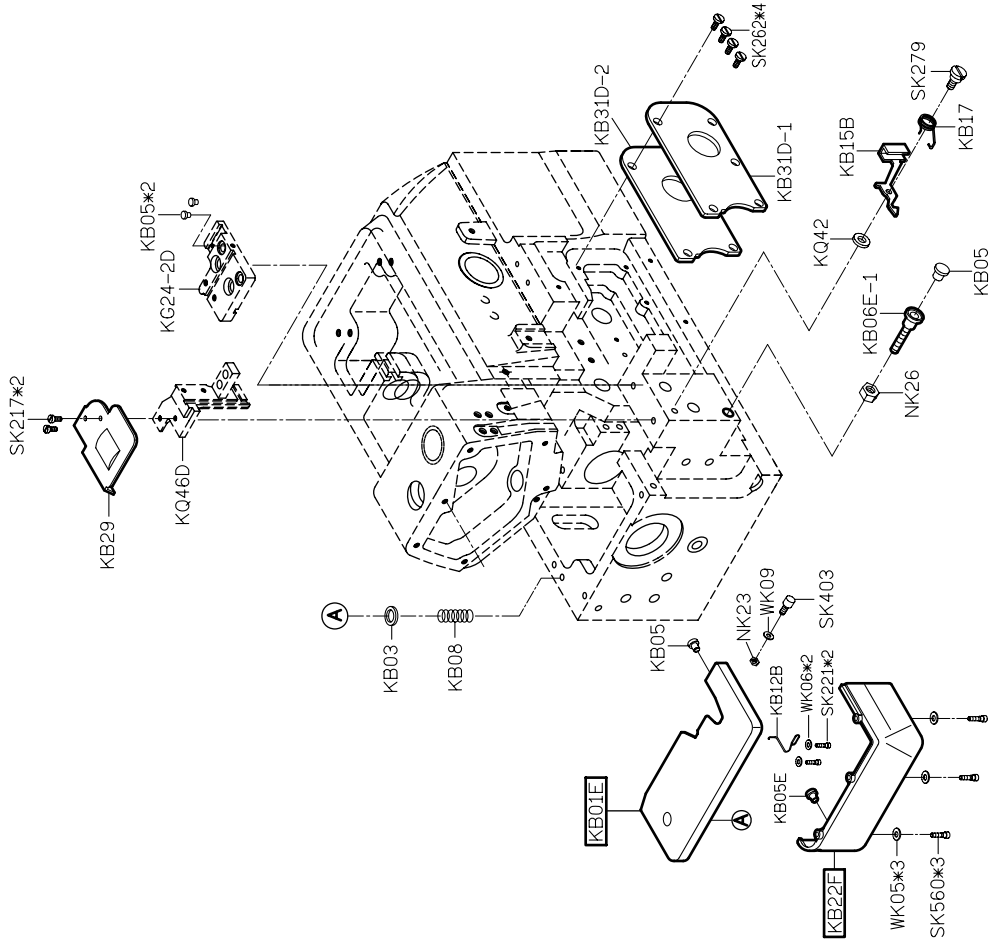
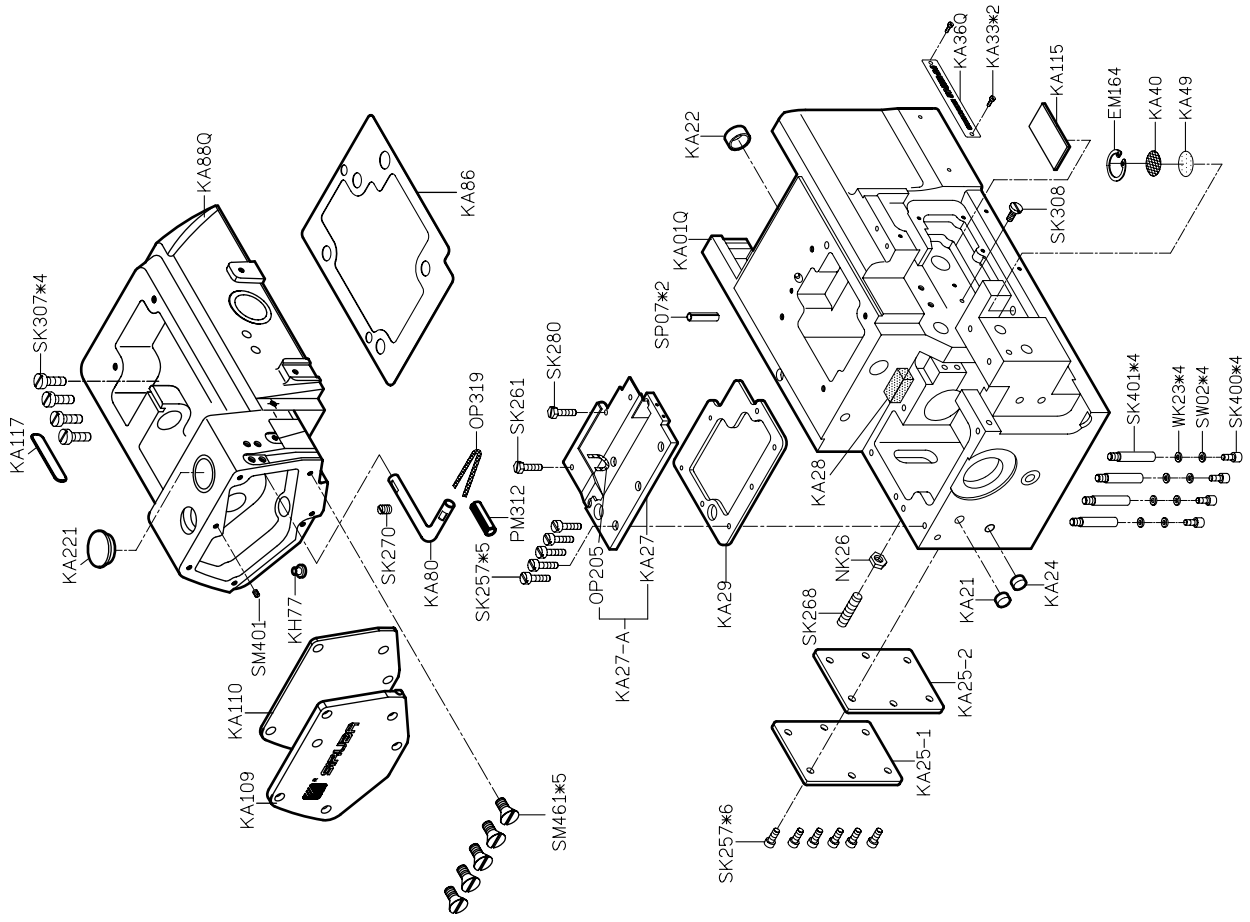

# PARTS LIST FOR KD GROUP

MODEL	五、六線車
PARTS NO	KD27D KD26D KP18 KP59 SK294 KD33

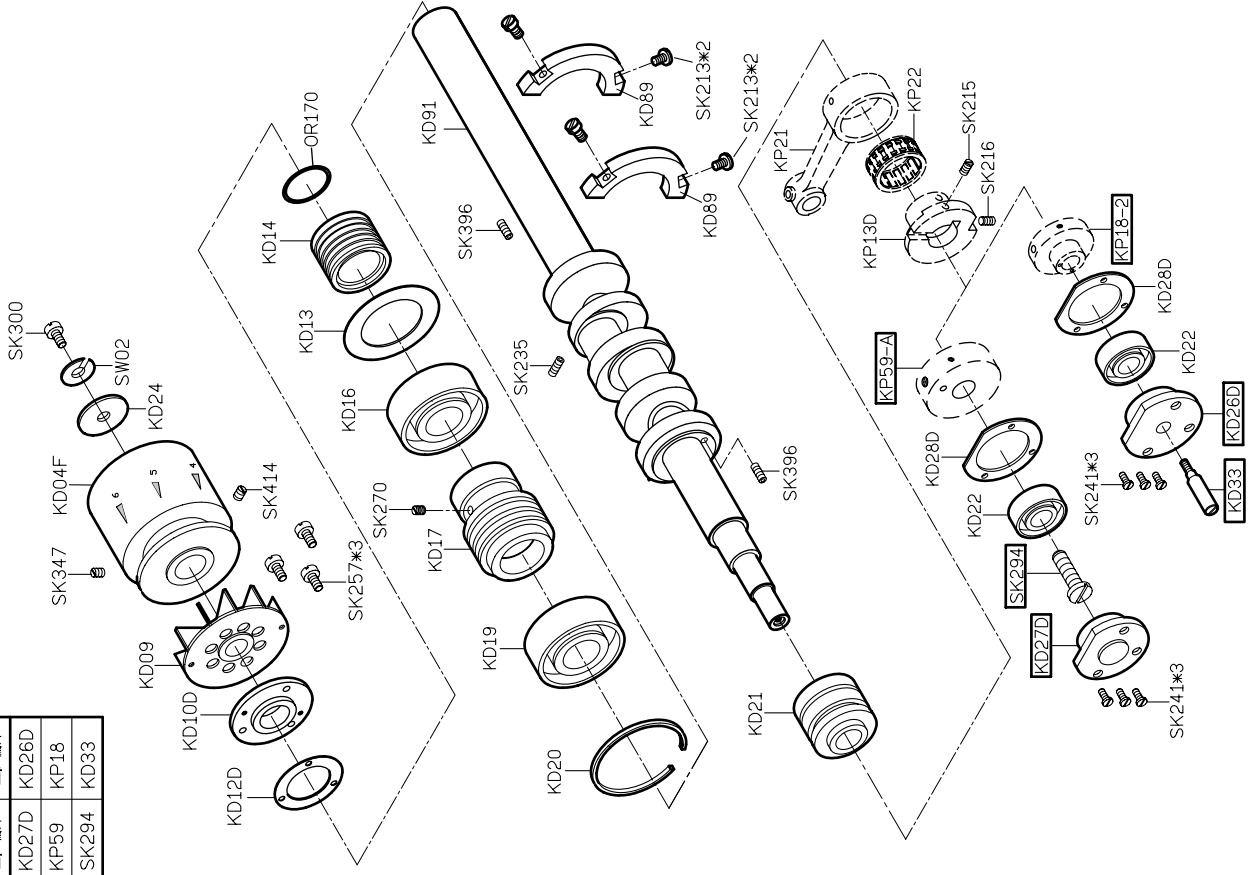

# PARTS LIST FOR KC GROUP

MODEL	三、四線車	五線車	六線車
PARTS NO	KC87 KC100 KC100 KC122	KC90 KC90 KC100 KC100	KC90 KC90 KC100 KC122

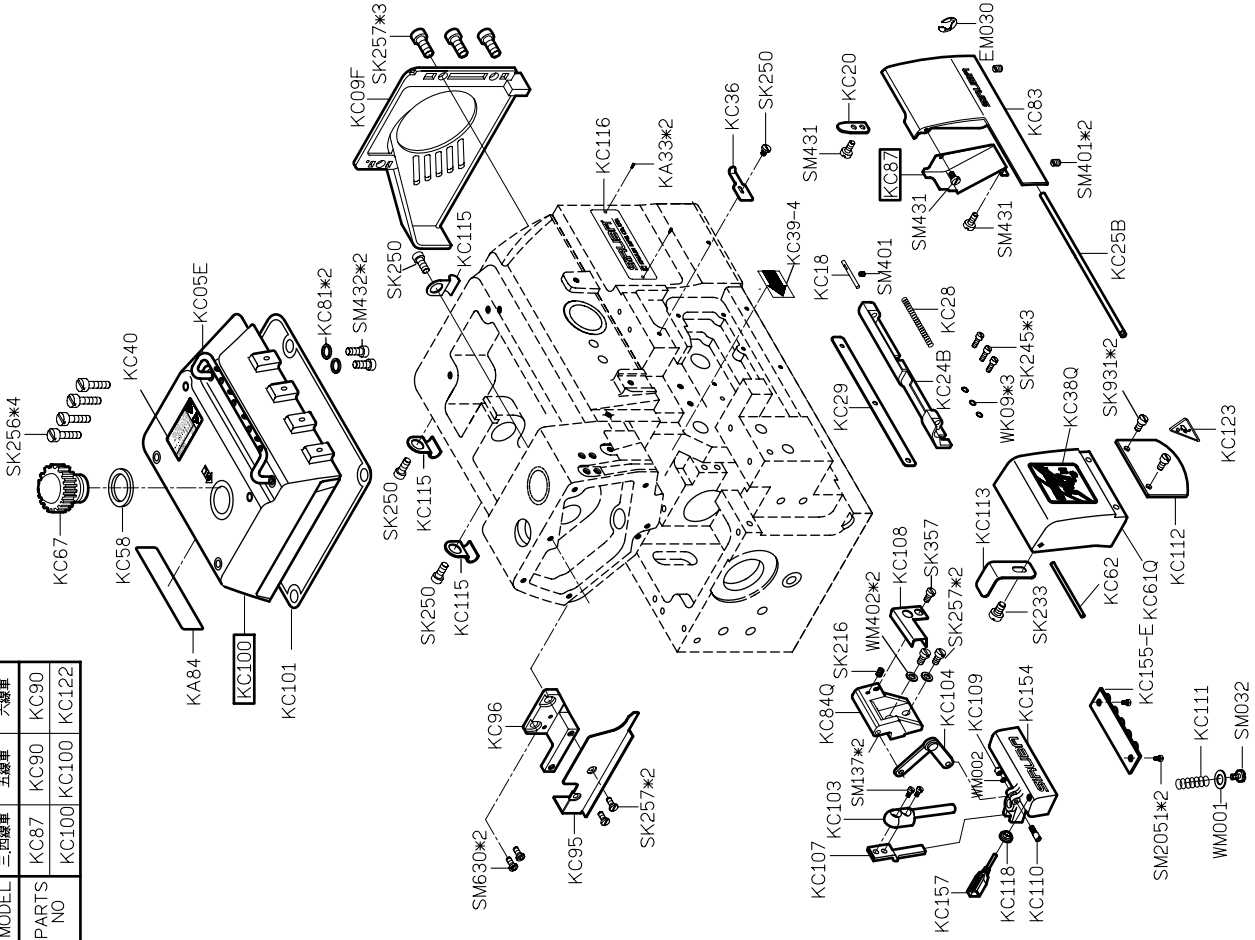

MODEL	3線車 / 5線車 / 4線車 / 6線車
PARTS NO.	KF87 KF86

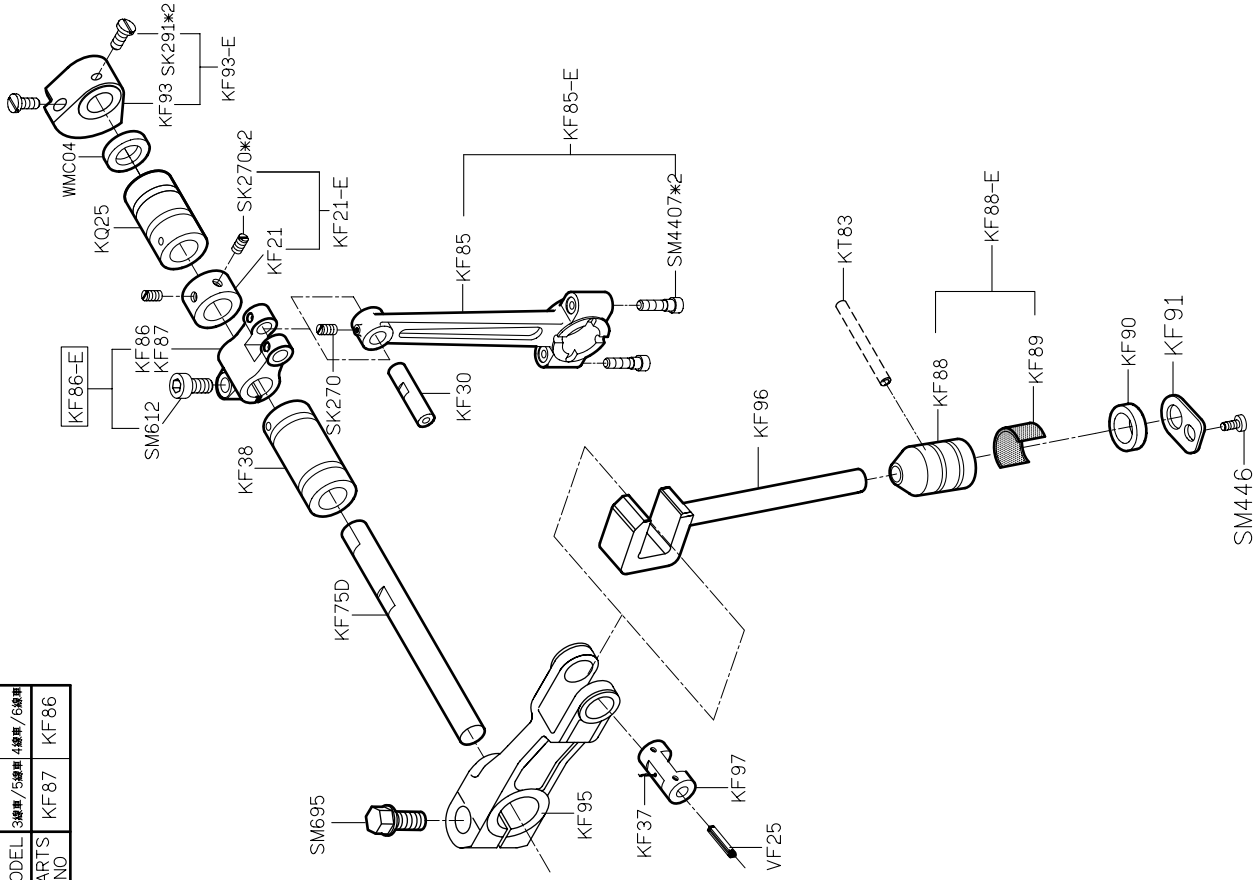

PARTS LIST FOR KF GROUP

MODEL	三線車	四線車	五線車	六線車
PARTS NO	KG60F	KG60F	KG11F	KG11F
	KG471	KG472	KG35	KG35
	KG81	KG80	KG81	KG80
			KG31D	KG32D
			KG37	KG37
			KG39	KG39
			KG10E	KG10E
			KG94	KG94
			KG30-1	KG30-1
			SM251	SM250 SM250

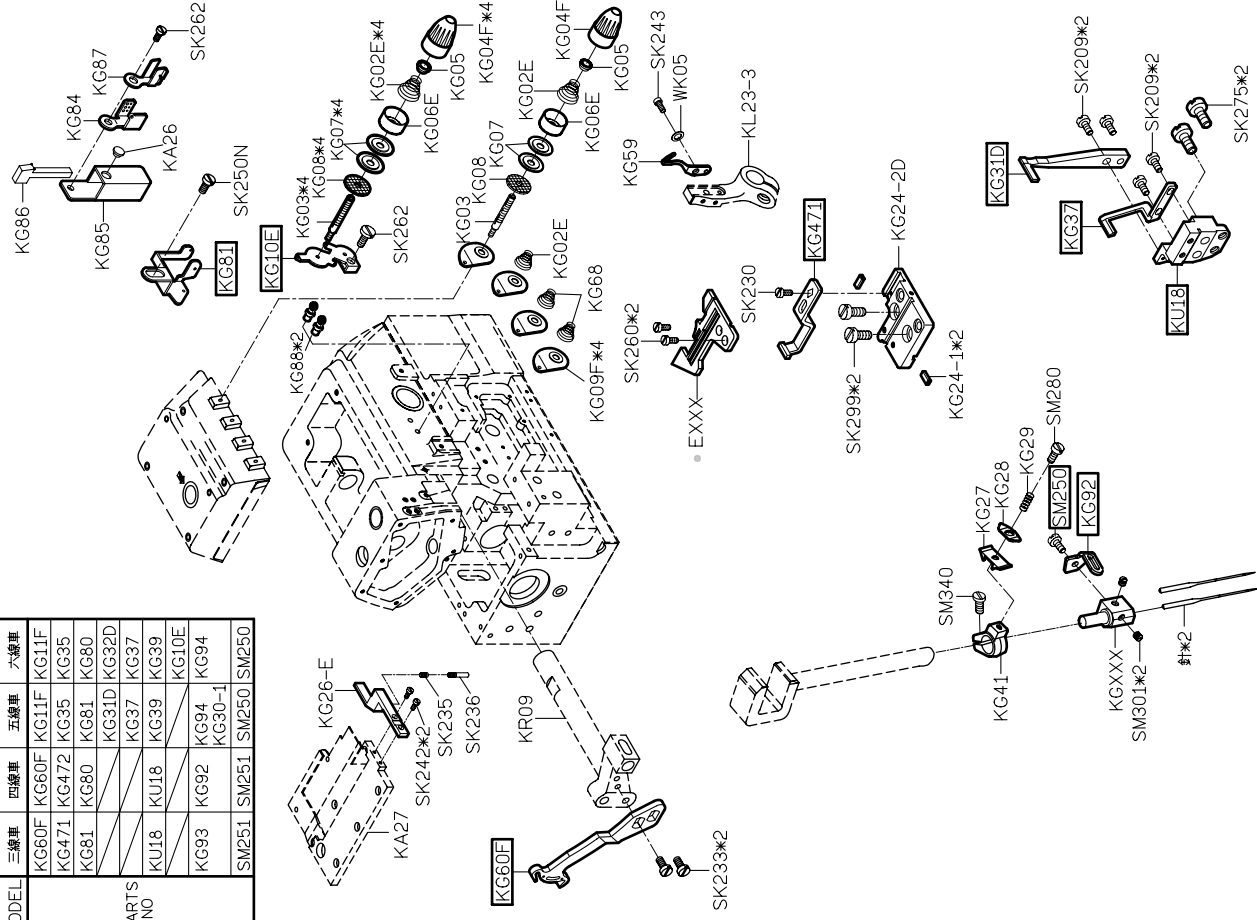

PARTS LIST FOR KG GROUP



PARTS LIST FOR KL GROUP

MODEL	三四線車	五六線車
PARTS NO	KL57	KL16
	KL15	KL11
		KL09B-E

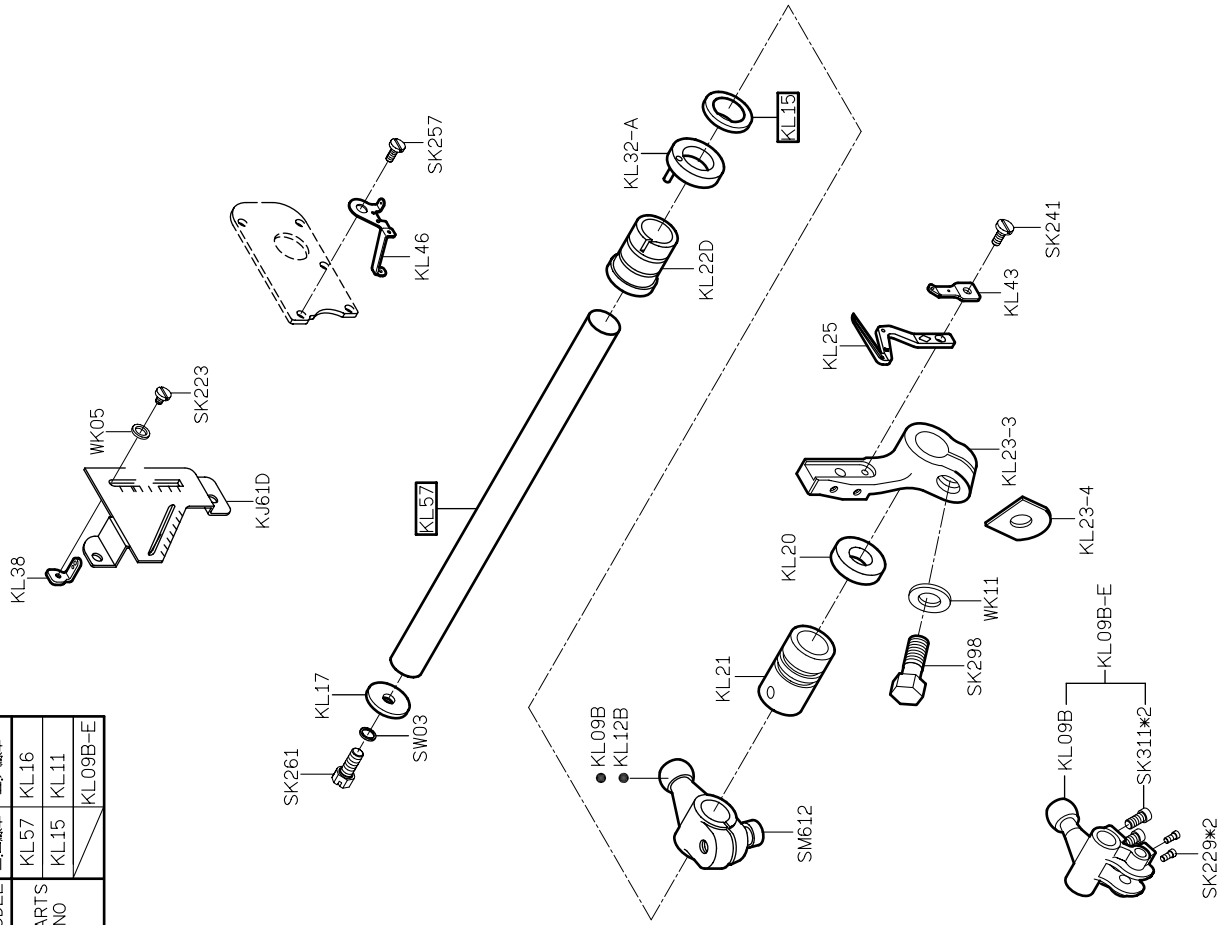

PARTS LIST FOR KJ GROUP

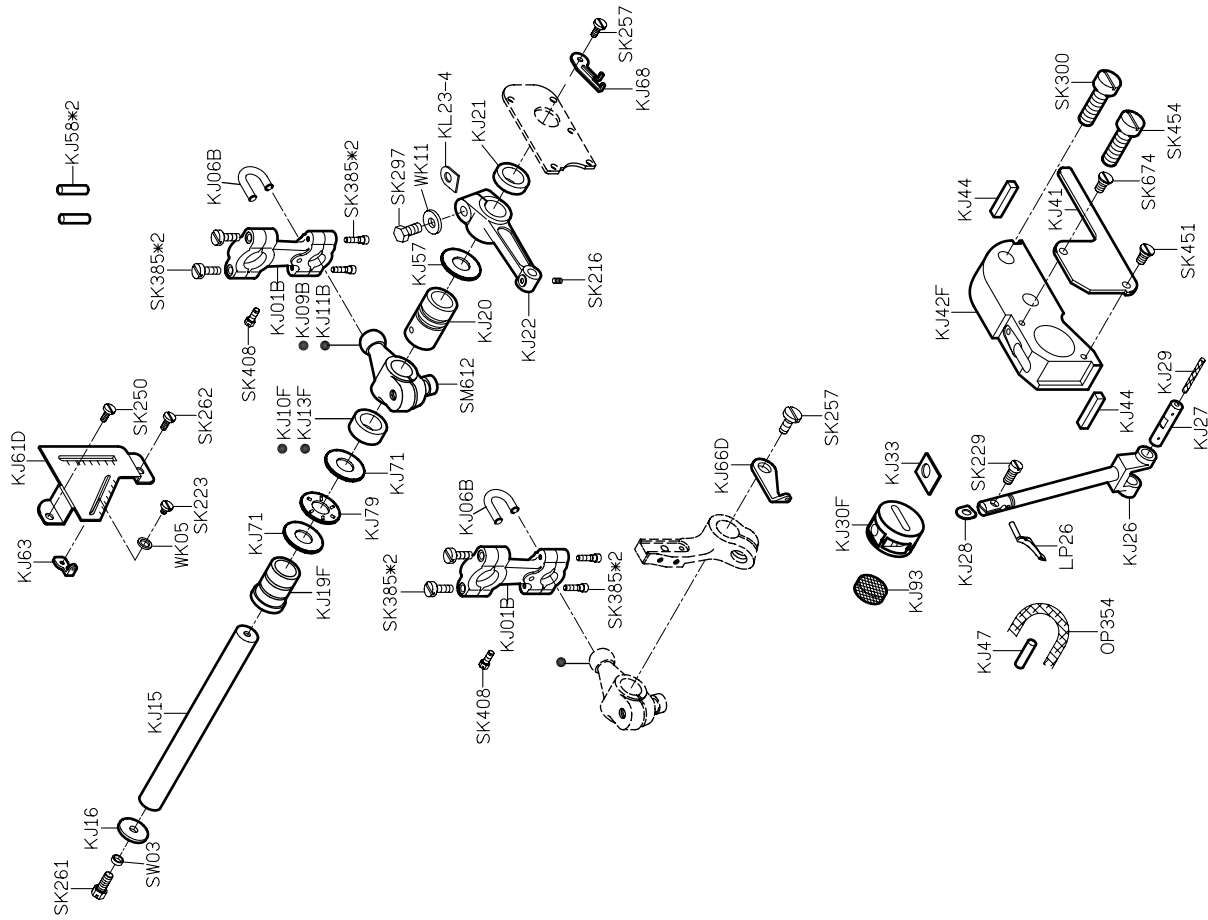

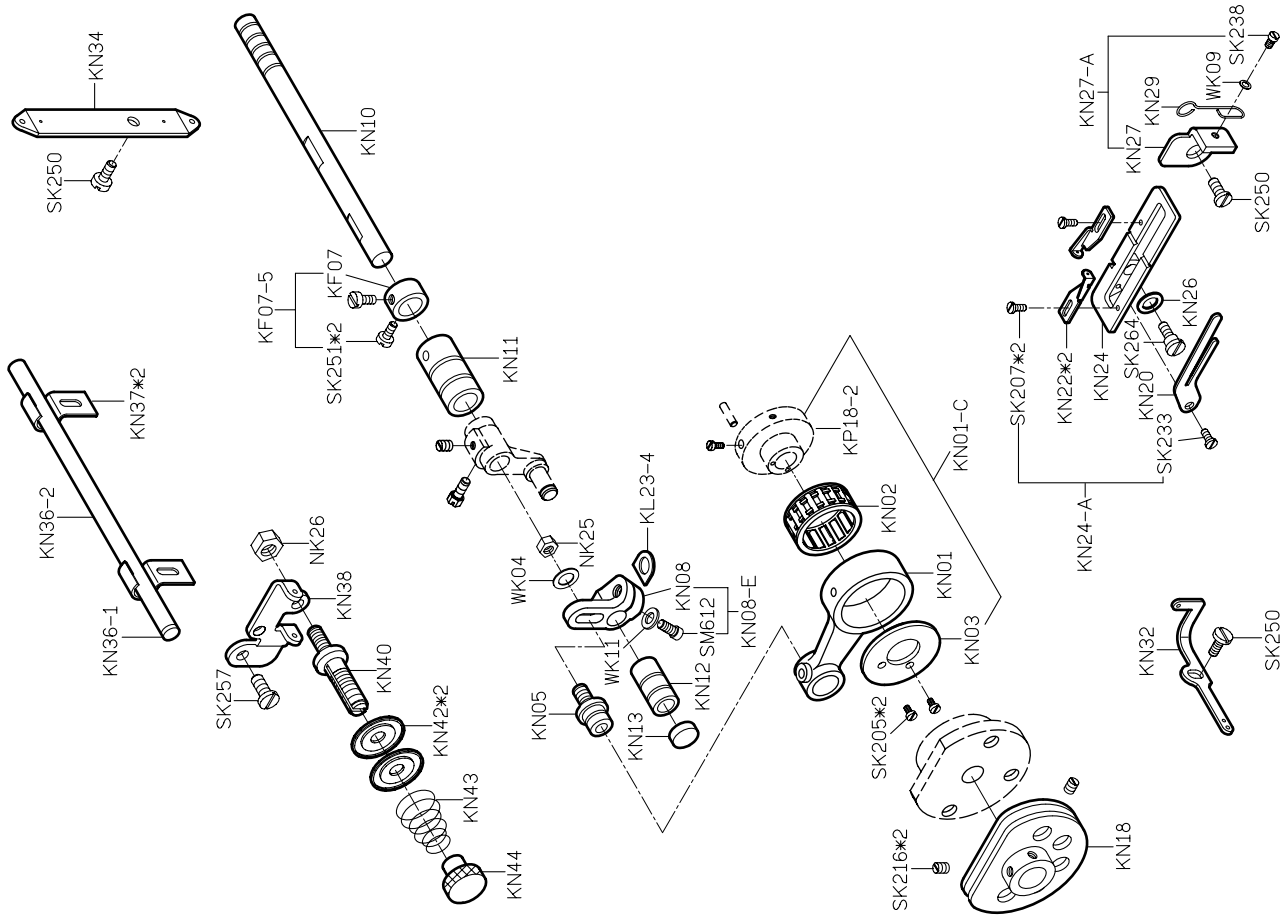

**PARTS LIST FOR KN GROUP**

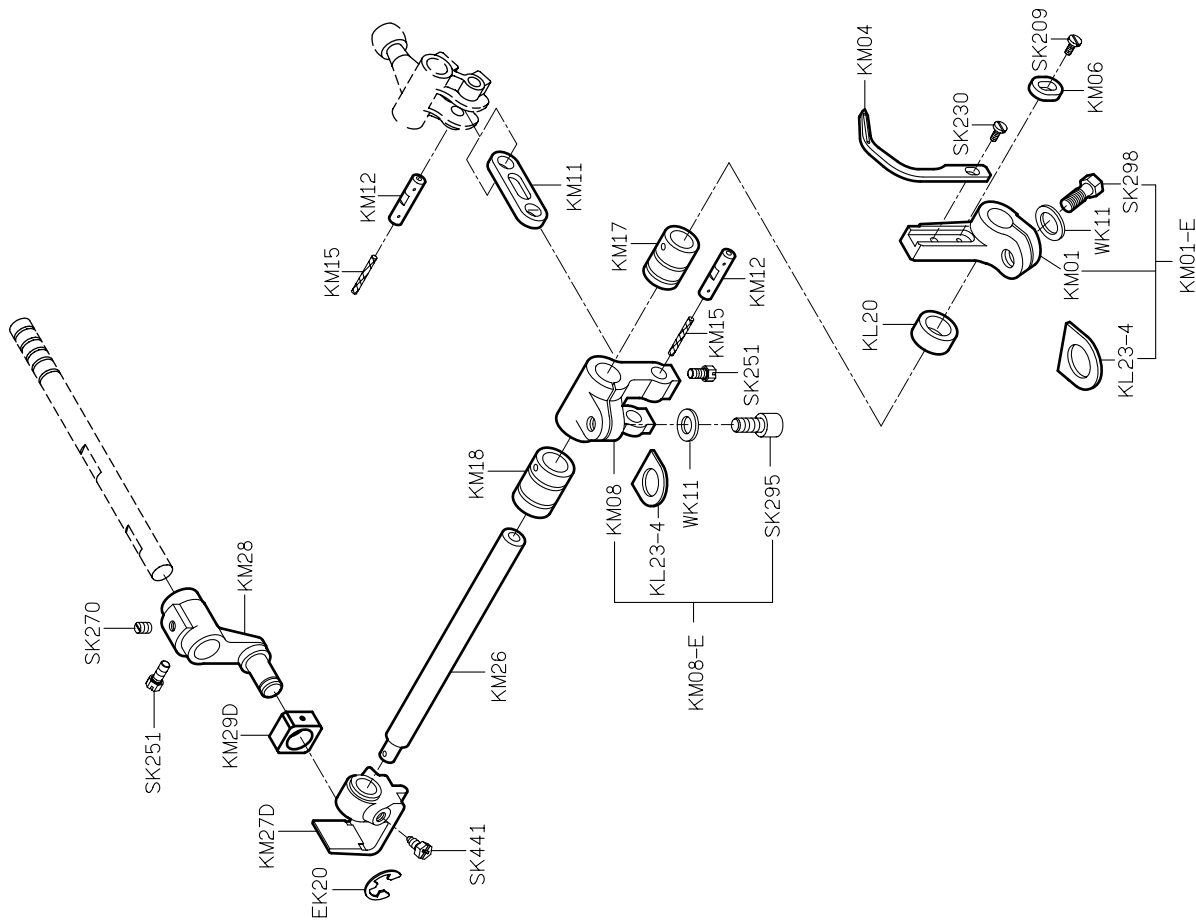

**PARTS LIST FOR KM GROUP**

# PARTS LIST FOR KP GROUP

MODEL	三 四線車	五 六線車
PARTS NO.	KP59	KP18-2

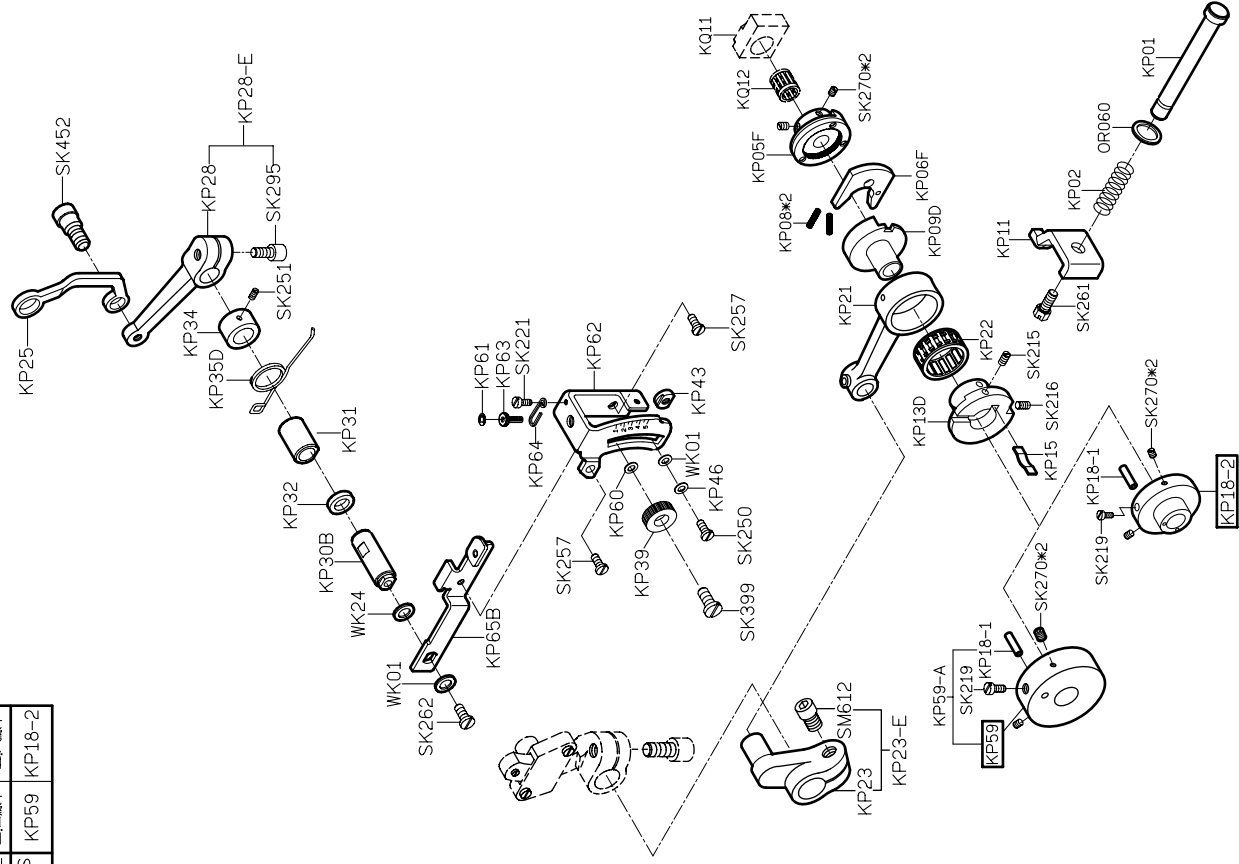

# PARTS LIST FOR KQ GROUP

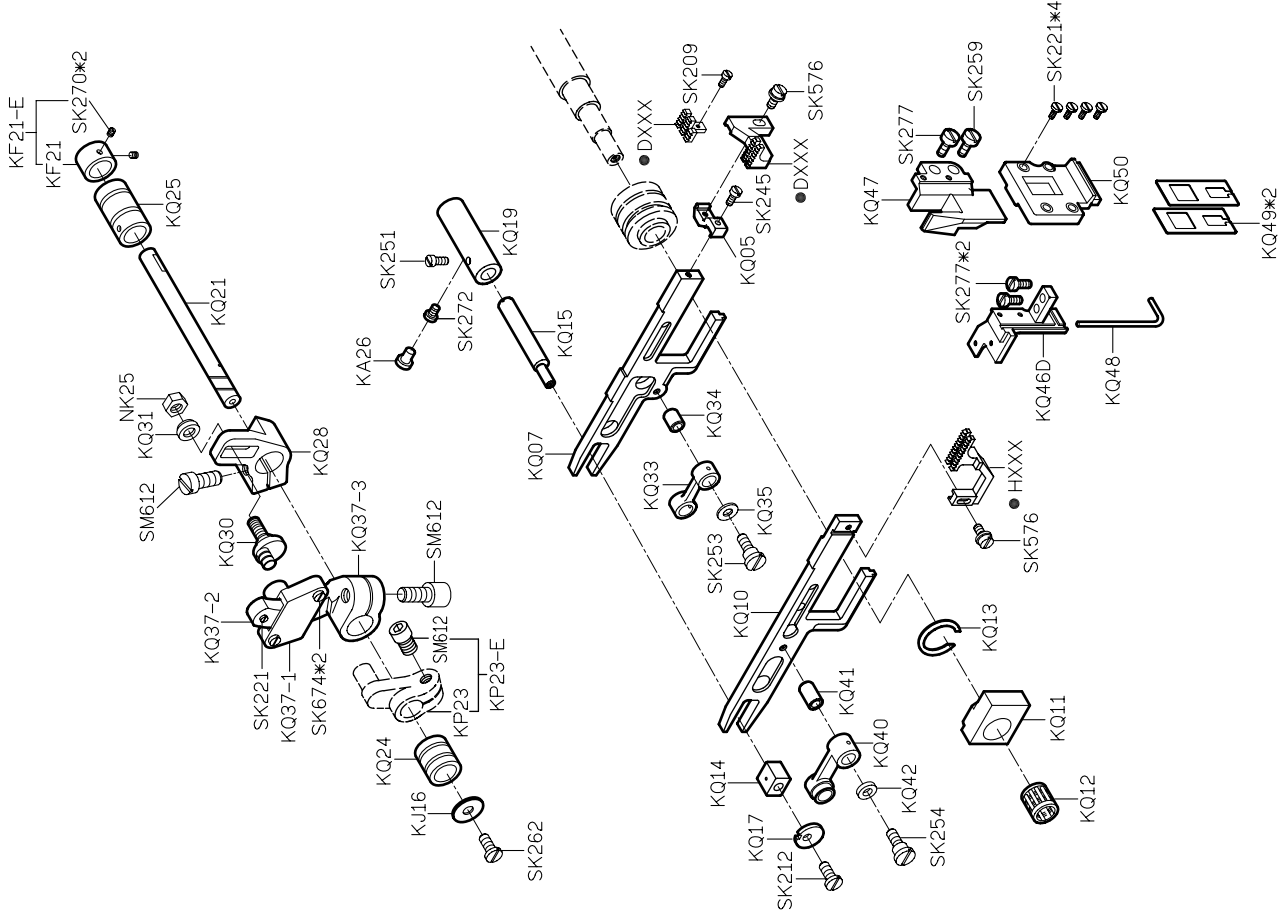

MODEL	三線車 / 四線車	五線車	六線車
PARTS NO	KR20 KR27 KR53	KR19 KR26 KR53	KR19 KR26 KR24

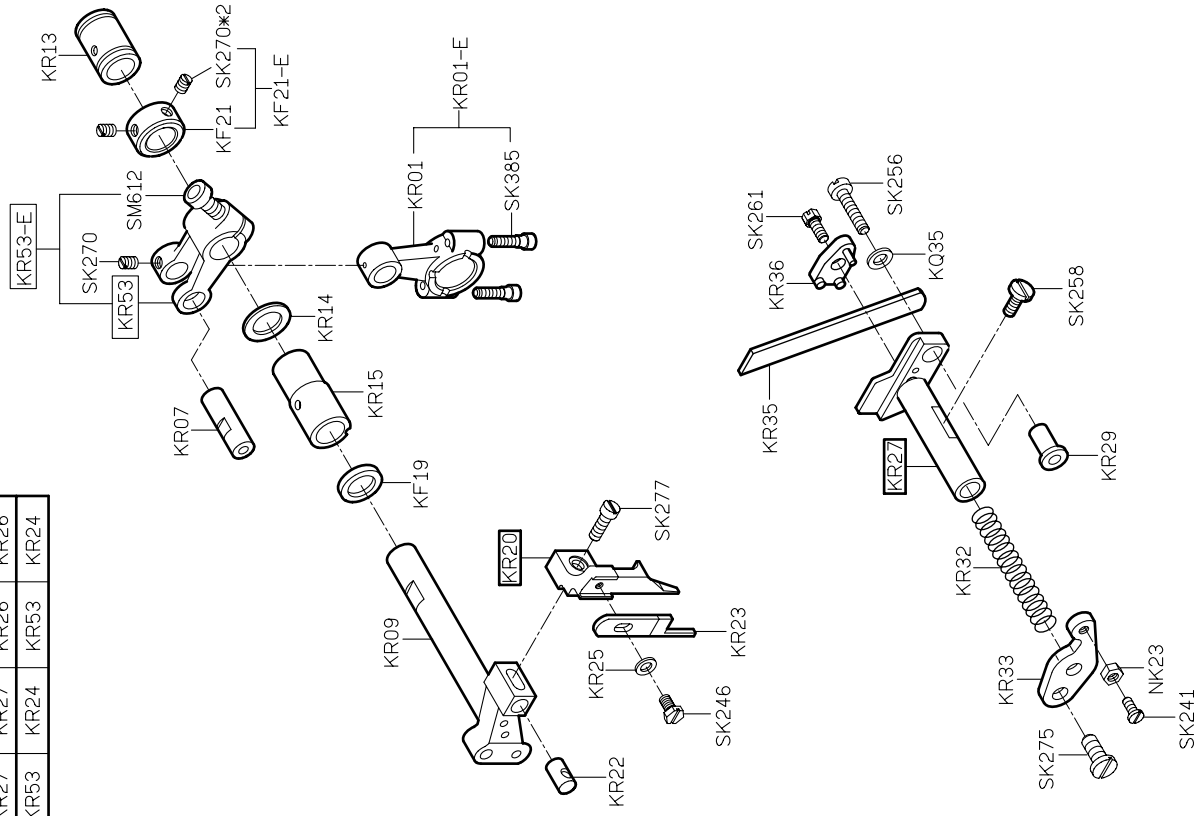

## PARTS LIST FOR KR GROUP

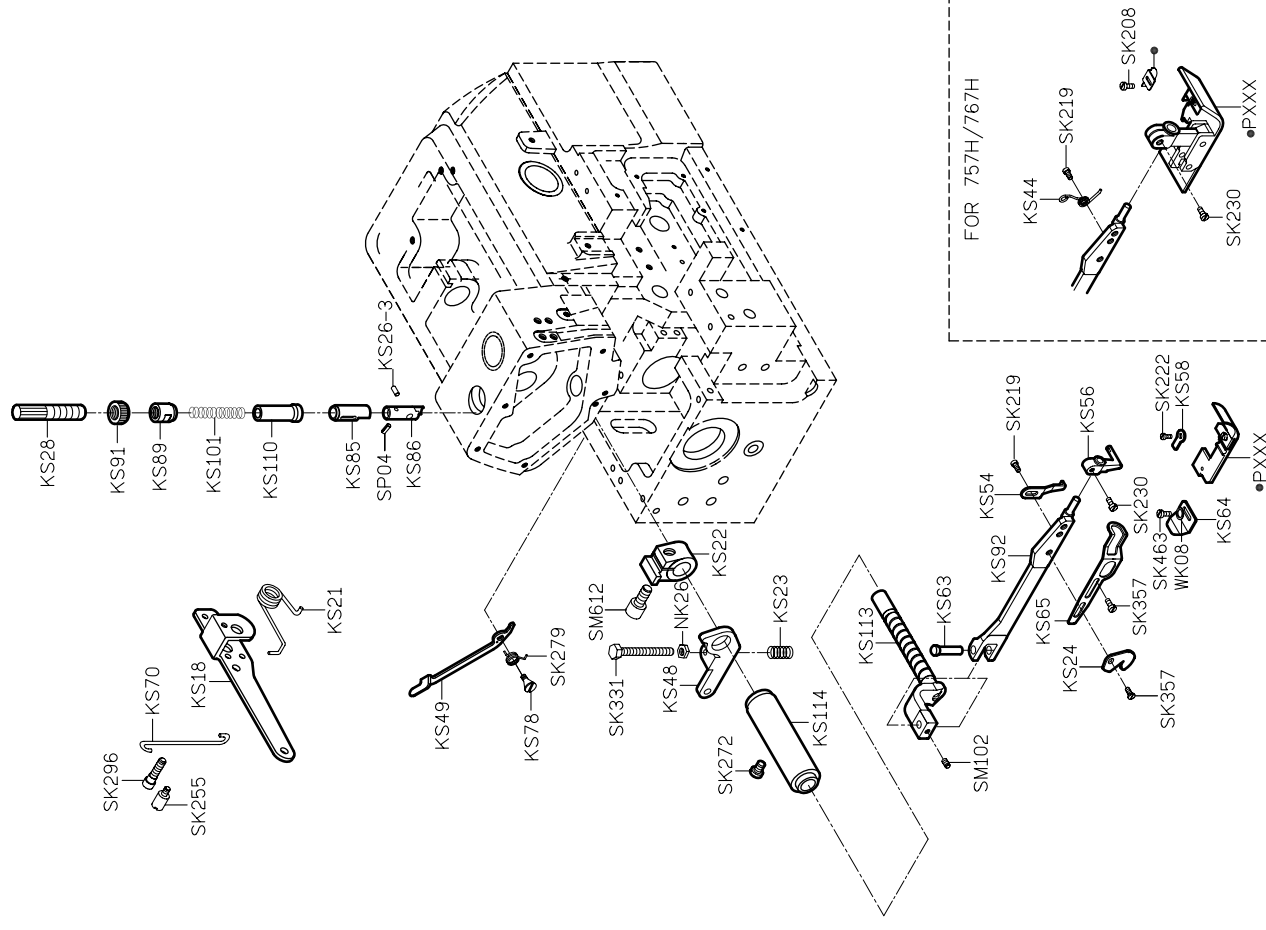

## PARTS LIST FOR KS GROUP

# PARTS LIST FOR KT GROUP

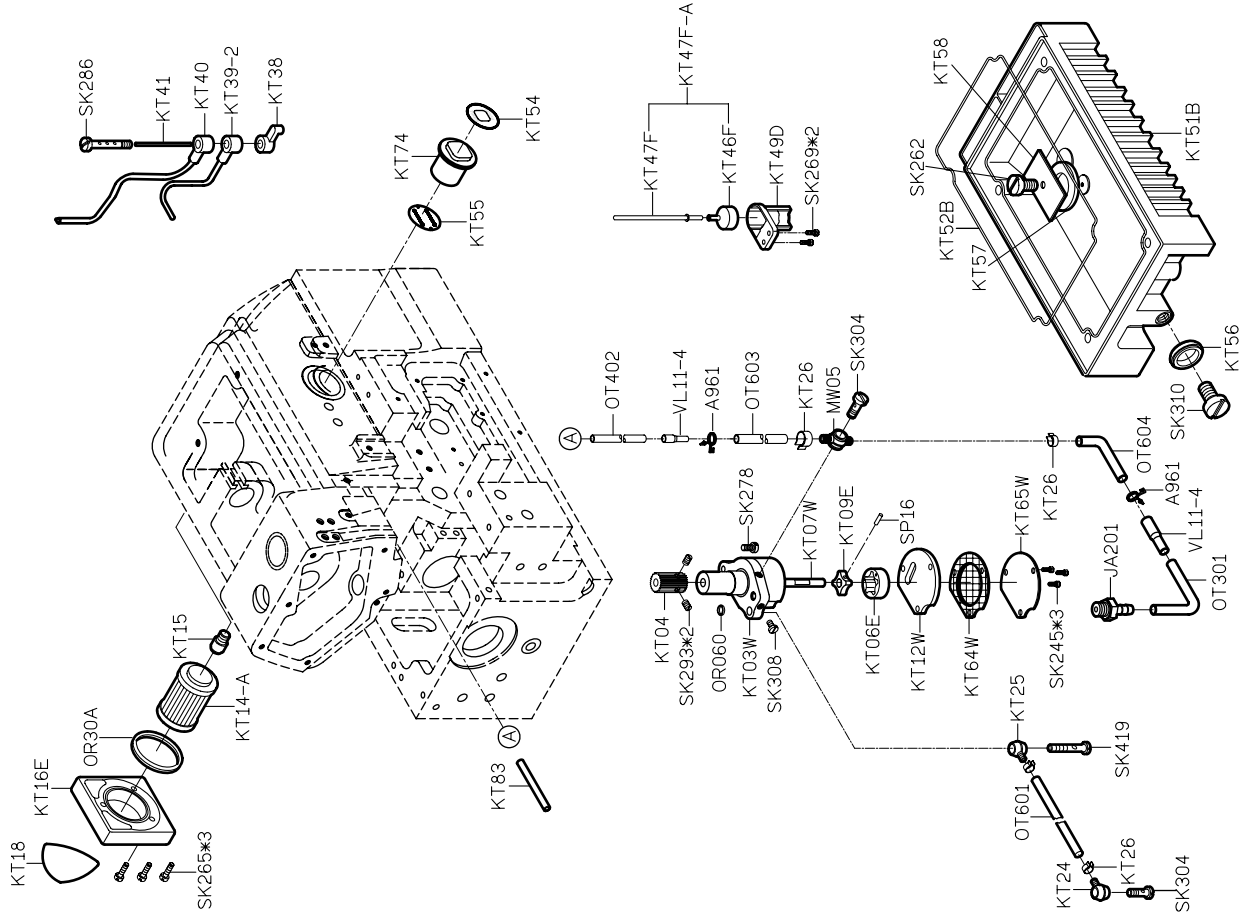

# PARTS LIST FOR KU GROUP

MODEL	三四線車	五、六線車
PARTS NO	KU40	KU39
	KU25	KU24
	KU15	KU14

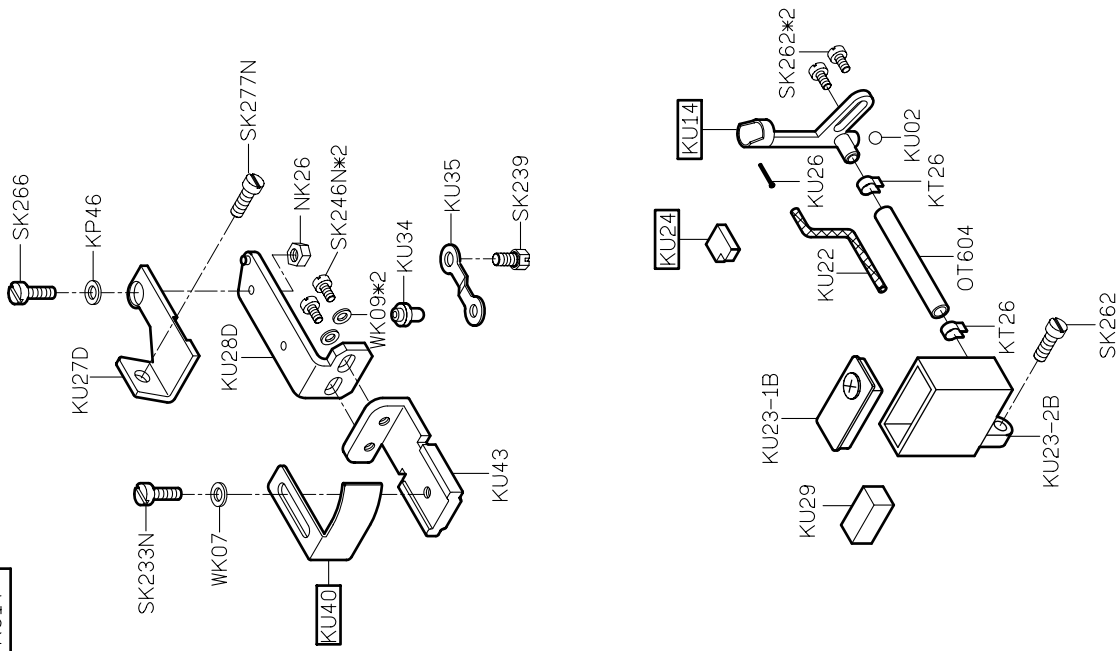

KW40E-3

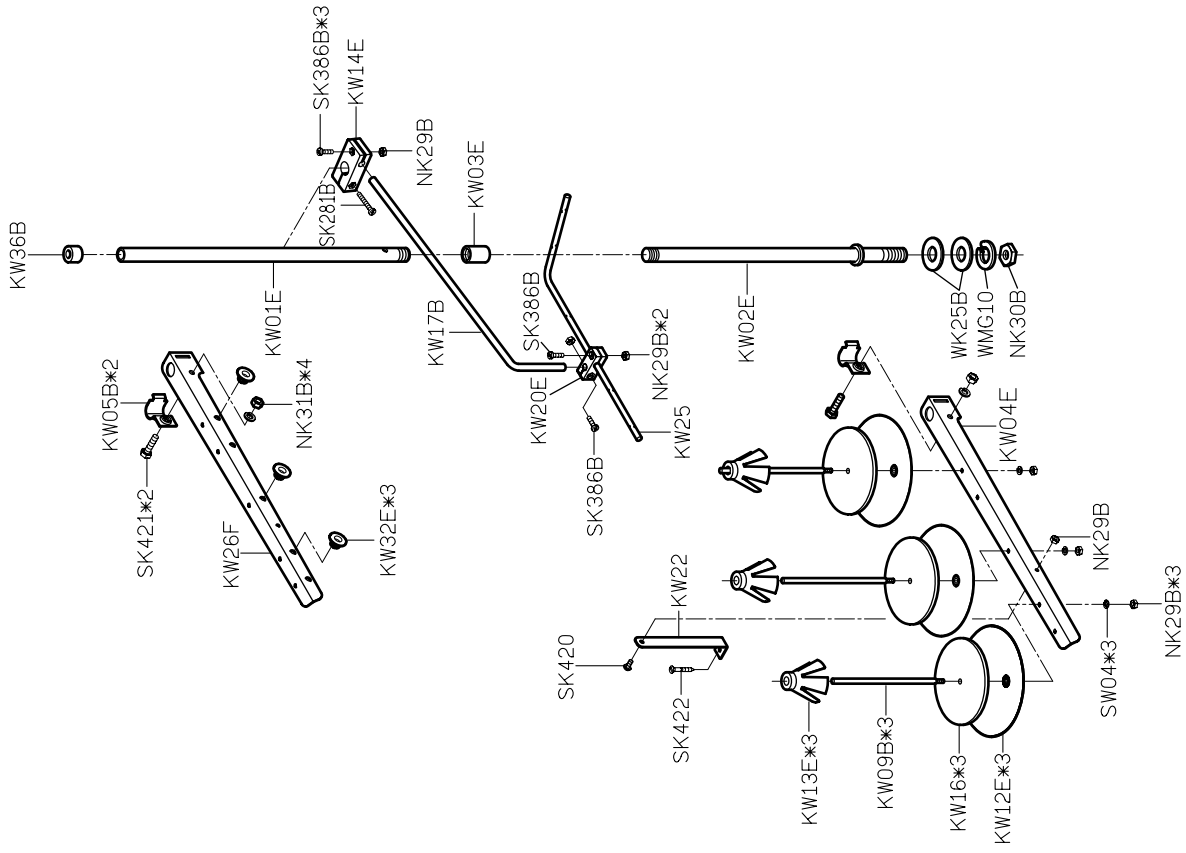

KW40E-4

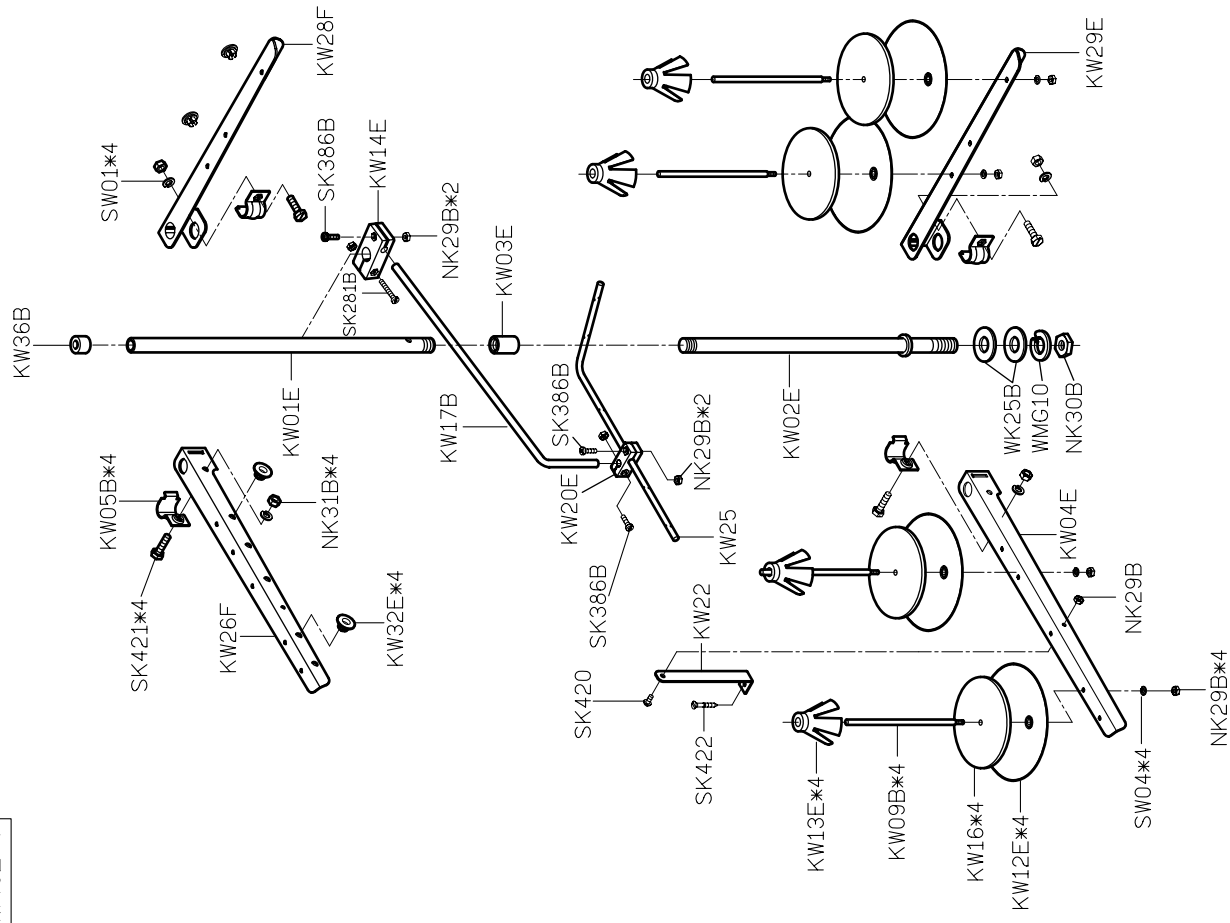

# PARTS LIST FOR THREAD STAND GROUP

KW40E-5

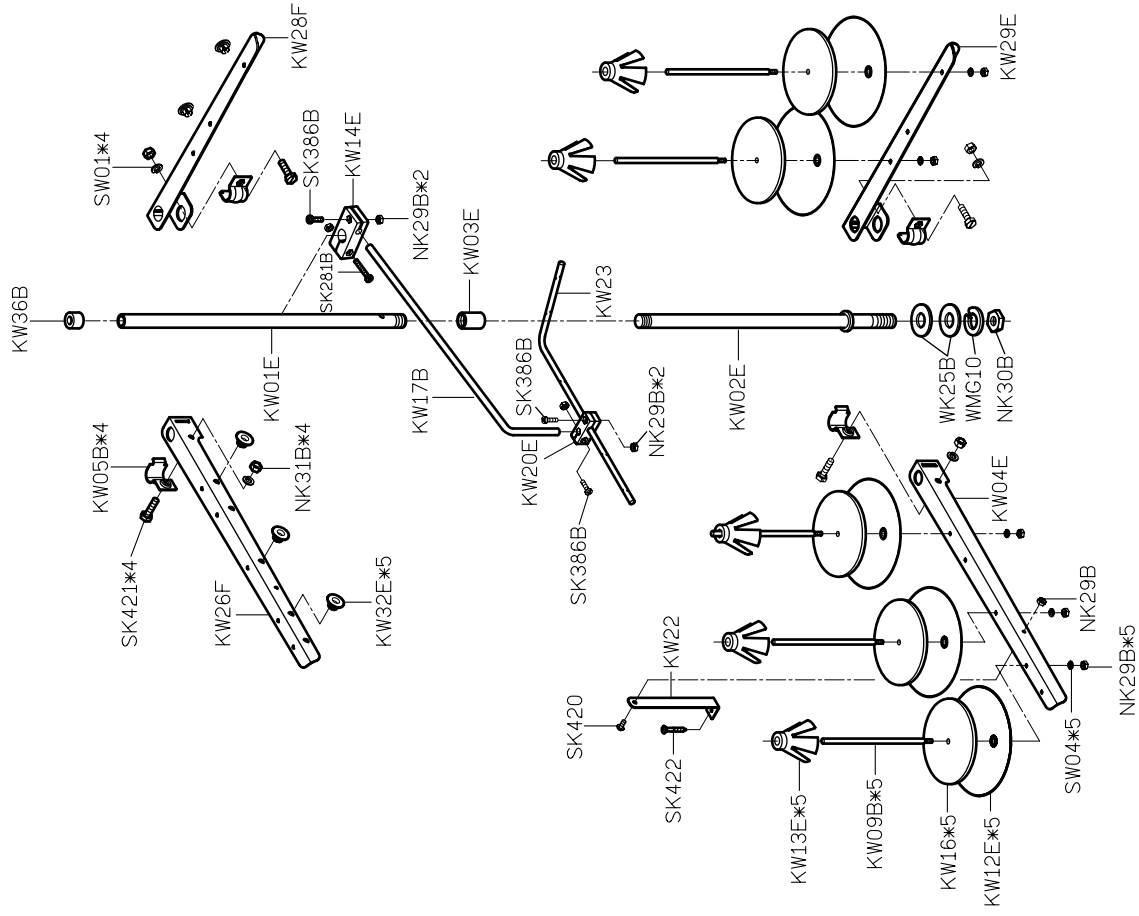

# PARTS LIST FOR THREAD STAND GROUP

KW40E-6

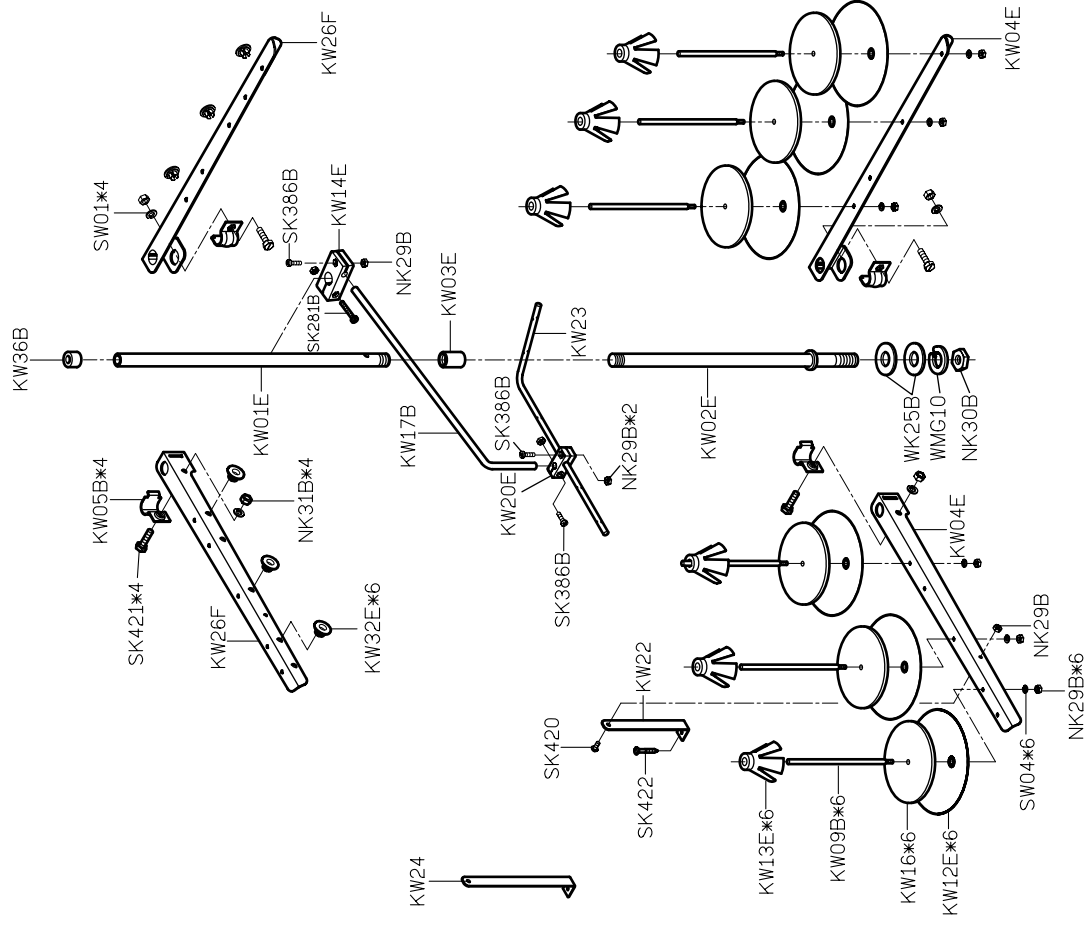

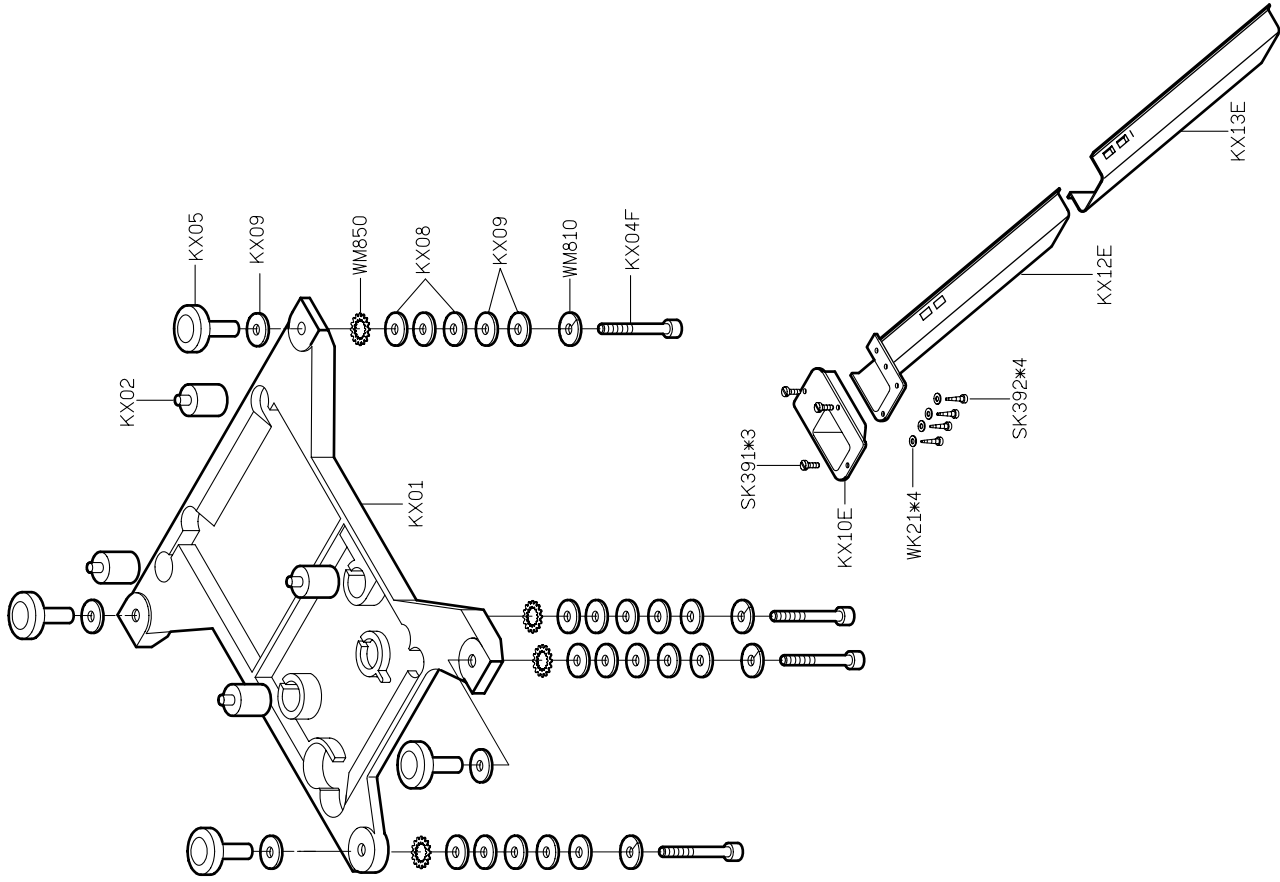

**PARTS LIST FOR KX GROUP**

KY01  
防塵罩

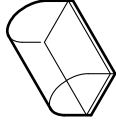

KY07  
開口板手

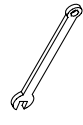

KY12  
六角板手



KY19  
穿線器

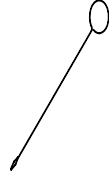

KY02-A  
油罐

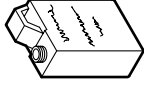

KY08  
開口板手



MY14  
內六角螺絲起子



KY20D  
腳踏板



KY03  
油壺

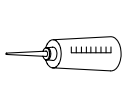

KY09  
開口板手



KY16  
一字起子

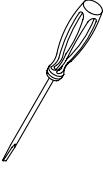

KY21-A/MY21  
鉤子/鍊條



KY04  
漏斗



KY10  
六角板手



KY17  
一字起子

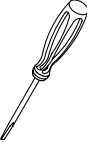

KY26F  
工具袋



KY05  
油壺



KY11  
六角板手



KY18  
鑷子



KR35  
下刀片

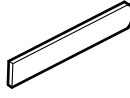

KT14-A  
濾油器



KZ03  
乾燥濟



針\*5  
車針

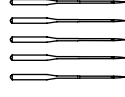

KZ08Q  
使用說明書



KZ08Q-2  
零件圖



SK216  
螺絲



KC158-E  
燈座電氣組



SK392\*2  
螺絲



KC146  
照明電源開關包裝盒





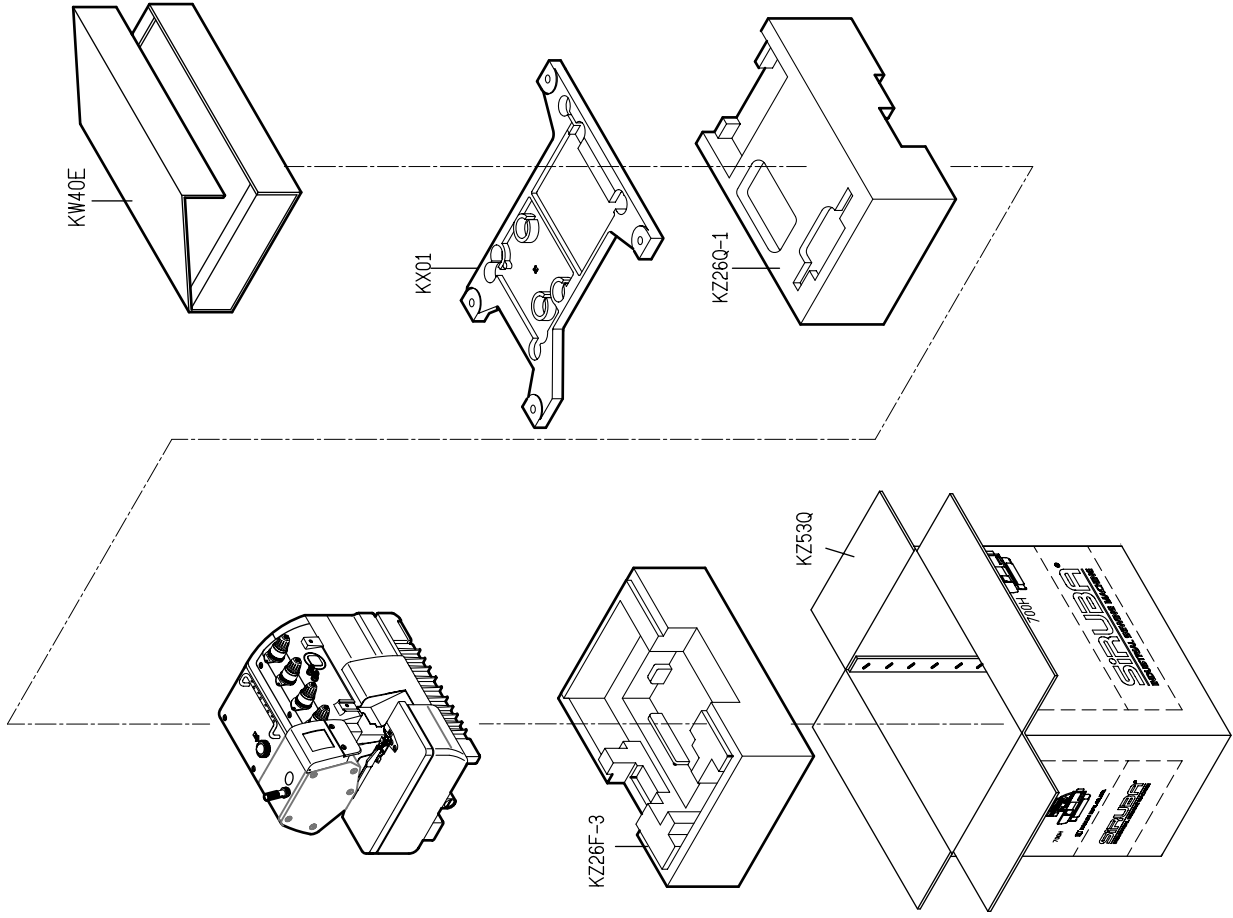



# 700H

高林股份有限公司 KAULIN MFG. CO., LTD.